

Introduction

The Trace Engineering DC250 & DC175 protects your battery, inverter and DC cables from damage caused by short circuits and overloads through use of a UL listed, high interruption capacity circuit breaker. This breaker is designed to interrupt the tremendous amount of power a battery can deliver when short circuited. It is also designed to have a long enough time delay to allow the inverter to surge to full power without nuisance tripping of the breaker. If the breaker does trip, it is easily reset.

The DC250 & DC175 provide the NEC (National Electrical Code) required overcurrent protection for residential and commercial applications. It also serves as a disconnect switch to provide isolation of the inverter from the battery. A metal enclosure provides protection from electrically "hot" terminals. Knockouts are provided for connection of conduit to protect the battery and inverter cables from physical damage (a NEC code requirement).

Additional space is provided in the enclosure to allow mounting of a second 250 amp or 175 amp breaker for a second inverter (*options GJ250 & GJ175*). Four knockouts are also provided to allow mounting of optional 110 amp, 60 amp and 15 amp DC breakers for use as solar array input disconnects or for DC load circuits (*options CD 110DC, CD60DC and CD15*). An optional DC bonding block (*DCBB*) is offered to simplify the negative and ground wiring. Holes are also provided in the back of the enclosure for mounting two net metering DC current shunts (DELTEC 500-50 or similar). Knockouts are provided on the top of the enclosure for connection of one or two Trace Engineering solar charge controllers or DC load controllers (*models C40, C30A, C30 or C12*).

Selection

The following table provides the recommended breaker size and minimum cable size for Trace Engineering inverters. Cable sizes are based on a maximum total length of up to 20 feet (positive + negative). For longer cables of up to 30 feet total, use the next larger cable size. Cable lengths over 30 feet total are not recommended. Long cables reduce the operating efficiency of the system.

Cable sizes shown are based on utilizing the full ability of the disconnect. If the system will be able to operate the inverter at full power continuously, larger cables may be required to meet the NEC or your local code.

Both the DC250 & DC175 accept #6 TO 250 MCM cables. The 15 amp breaker requires a #10 ring terminal and the 60 amp and 110 amp breakers require a 1/4" ring terminal for wiring connection. Trace Engineering offers UL listed, super-flexible cables for use with the DC250 & DC 175. See our price list for more information.

USE ONLY ALL COPPER CABLES.

Inverter Model	Breaker Size	Cable Size (minimum)
SW2512	250 amp	#4/0 AWG / 107 mm ²
SW4024	250 amp	#4/0 AWG / 107 mm ²
SW4048	175 amp	#2/0 AWG / 67.4 mm ²
SW5548	175 amp	#2/0 AWG / 67.4 mm ²
DR1512	175 amp	#2/0 AWG / 67.4 mm ²
DR2412	250 amp	#4/0 AWG / 107 mm ²
DR1524	175 amp	#2/0 AWG / 67.4 mm ²
DR2424	175 amp	#2/0 AWG / 67.4 mm ²
DR3624	250 amp	#4/0 AWG / 107 mm ²
U2512	250 amp	#4/0 AWG / 107 mm ²
U2624	175 amp	#2/0 AWG / 67.4 mm ²
U2548	175 amp	#2/0 AWG / 67.4 mm ²

NOTE: This table assumes 75°C cables in conduit @ 30°C (86°F)

For stacked SW and DR series inverters, use two breakers. Each inverter requires its own positive and negative cables from the battery and breaker. Do not parallel the inverter terminals together when using two breakers. If the bonding block (*DCBB*) option is not used, connect the DC negative terminals of the two inverters together with 2/0 AWG cable.

For stacked U series inverters, use single a single breaker and cables from the battery and inverter. Use of the DC250 with stacked U2512 inverters is not recommended.

The SW and DR series of inverters are designed to accept 2 inch conduit when equipped with an optional conduit box (*SWCB and DRCB*). Connection of the conduit box to the disconnect using the 2" knockouts requires a 3/4" offset fitting due to the differences in the spacing of the knockouts on the wall surface. No offsets are required for the smaller knockouts on the top provided for connection to a solar charge controller, etc.

Consult your applicable electrical code for more information regarding acceptable cable sizes, conduit and system grounding requirements.

Installation

The battery, disconnect and inverter should be located as close together as possible without being in the same enclosure. Batteries produce explosive gasses which can be ignited by the breaker.

Connections to the inverter and battery require ring type lugs with a 5/16 inch hole on the ends of the cables. The lugs can be crimped and/or soldered to the cable. If crimped, the connection should be sealed with either a mastic filled heatshrink or several layers of a quality electrical tape. Trace Engineering offers pre-made cables of several sizes and lengths for use with the DC250 & DC175 disconnects and our inverters.

Install all options (DC bonding block, additional DC breakers, shunts, etc.) before mounting the disconnect on the wall. Do not remove any knockouts until required - no openings in the enclosure can be left unfilled once the disconnect is fully installed. Use a flat screwdriver and pliers to pry out the knockouts.

A single wire is provided on the first main breaker for connection to a single 15 amp DC load breaker. Do not use it with a 60 amp breaker. Either replace the wire with a #6 wire with 1/4" ring terminals, or make the connection at the DC terminals of the inverter (see attached diagrams). Be careful to not overtighten the bolt which attaches the lug on the back side of the breaker or it may strip out.

Mount the disconnect in a vertical position near the DC terminals of the inverter. Mount the end marked TOP up. Attach the disconnect with appropriate hardware to a secure surface. Connect the conduit and pull the cables. Make the cable connections to the disconnect first, then the inverter and finally the battery. Check the cables for correct polarity at the breaker with a voltmeter **BEFORE** turning on the breaker and providing power to the inverter.

CONNECTING THE INVERTER BACKWARDS (REVERSE POLARITY) WILL DESTROY THE INVERTER!

Since the terminals of the breakers may be energized by the battery or a solar array when servicing the system, be careful with any tools when working inside the disconnect.

Torque Recommendations

To ensure good quality electrical connections, the hardware should be torqued to the following recommended values. The connections should be checked semi-annually for both tightness and corrosion. It may be necessary to re-torque the terminals periodically if the system is operated near rating of the disconnect.

Recommended Torque Values for Electrical Terminals	
1/4-20 nuts on the 60A breakers	80 inch-pounds.
10-32 nuts on the 15A breakers	35 inch-pounds.
5/16" socket screws	275 inch-pounds.
7/32" socket screws	125 inch-pounds.
5/32" socket screws	80 inch-pounds.
1/8" socket screws	35 inch-pounds.

IMPORTANT SAFETY INSTRUCTIONS

SAVE THESE INSTRUCTIONS !

This manual contains important safety and operating instructions as prescribed by ANSI/UL specifications for DC disconnects used in inverter applications. This manual covers Trace Engineering model number DC250 and DC175 disconnect for use in Residential and Commercial inverter applications.

The DC250 and DC175 has been certified by ETL to UL specification UL Standard 508 (draft), Industrial Control Panels for use in Residential Photovoltaic power Systems. It is also approved to CSA standard CSA-22.2 No. 14, Industrial Control Equipment.

General Precautions

1. Before using the DC disconnect, read all instructions and cautionary markings on (1) the DC disconnect, (2) the inverter and (3) the all other equipment.
2. To reduce risk of electric shock, disconnect all wiring before attempting any maintenance or cleaning. Turning off controls will not reduce this risk. Solar modules produce power when exposed to light - cover them with opaque material before servicing or connecting.
3. **WARNING - WORKING IN VICINITY OF A LEAD ACID BATTERY IS DANGEROUS. BATTERIES GENERATE EXPLOSIVE GASES DURING NORMAL OPERATION.** Provide ventilation to outdoors from the highest point of the battery compartment.
4. NEVER charge a frozen battery.
5. No terminals or lugs are required for hook-up of the DC wiring to the main breaker. Wiring should be rated for 75 °C and should be no less than 6 AWG / 13.3 mm² gauge wire. A #10 (4 mm) ring terminal must be provided for the optional 15 amp circuit breaker. A 1/4" (6 mm) ring terminal must be provided for the optional 60 amp or 110 amp circuit breakers.
6. Insulate tool handles with tape etc. to reduce the chance of a short circuit occurring. Spark or short-circuits can cause an explosion..
7. Tools required to make DC wiring connections: Wire strippers, Phillips screw driver #2, Slotted screw driver 5/32" (4.5 mm), 3/8" (9 mm) wrench, 7/16" (11 mm) wrench, 5/16" hex key, 7/32" hex key, 5/32" hex key and a 1/8" hex key.
8. This charge/load controller is intended to be used with a battery supply of 12 to 125 VDC nominal voltage.

9. Instructions for mounting: Mount with the end top up on a vertical surface only. Horizontal mounting is not acceptable.
10. For battery installation and maintenance: read the instructions provided with the batteries prior to operating.
11. Although over current protection for the DC inverter cables is provided as an integral part of this unit, additional over current protection of the DC wiring may be required as part of the system installation. Refer to local electrical codes for requirements.
12. **GROUNDING INSTRUCTIONS** - This DC disconnect should be connected to a grounded, metal, permanent wiring system. Connections to the grounding system should comply with all local codes and ordinances. A #10-32 stud is provided for grounding the DC disconnect enclosure. An optional DC system bonding block is available for for entire system grounding. A toothed star washer must be located on the grounding stud or under the bonding block to ensure electrical contact to the chassis of the DC disconnect.

Personal Precautions

1. Someone should be within range of your voice or close enough to come to your aid when you work near batteries.
2. Have plenty of fresh water and soap nearby in case battery acid contacts skin, clothing, or eyes.
3. Wear eye protection and protective clothing. Avoid touching eyes while working near batteries.
4. If battery acid contacts skin or clothing, wash immediately with soap and water. If acid enters an eye, immediately flood the eye with running cold water for at least 15 minutes and get medical attention immediately.
5. Baking soda neutralizes spilled Lead Acid electrolyte. Vinegar neutralizes spilled NiCad electrolyte. Keep a supply on hand.
6. **NEVER** smoke or allow a spark or flame in vicinity of a battery or generator.
7. Be extra cautious to reduce the possibility of dropping a metal tool onto batteries. It might spark or short-circuit batteries or other electrical parts that may cause an explosion. Cover wrench handles with plastic tape or vinyl dip coating material.
8. Remove personal metal items such as rings, bracelets, necklaces, and watches while installing the system. A single battery can produce short-circuit current high enough to weld a ring to a battery terminal or like metal, causing severe burns.

RELEASE STATUS PRODUCTION

LTR	REVISION DESCRIPTION	DATE	APPRVD
B	MOVED DCBB AND CUTOUTS	10-96	RWG

2220 MOUNTING KIT

- 4#414 10-32 X 3.5" SCREWS (6 FOR DUAL UNITS)
- 8#486 #10 STAR WASHERS (10 FOR DUAL UNITS)
- 8#442 10-32 HEX NUTS (10 FOR DUAL UNITS)
- 2#2142 MOUNTING CLIPS (4 FOR DUAL UNITS)
- 6#2157 #12 5/8" SHEET METAL SCREWS S/S
- 6#465 FLAT WASHERS
- 4#491-1 10-32 100° X 5/16" FLAT HEAD S/S

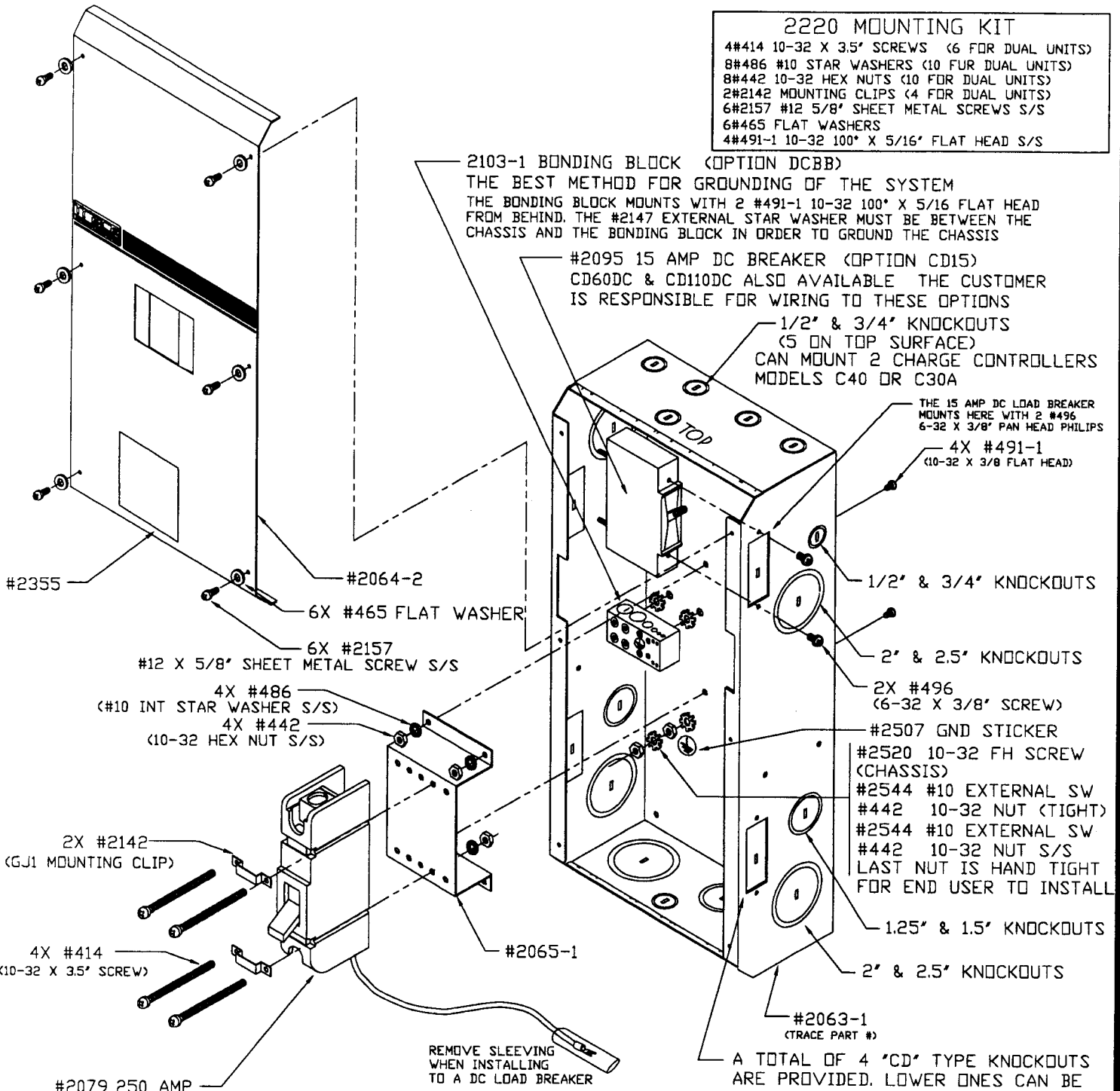

2103-1 BONDING BLOCK (OPTION DCBB)

THE BEST METHOD FOR GROUNDING OF THE SYSTEM

THE BONDING BLOCK MOUNTS WITH 2 #491-1 10-32 100° X 5/16 FLAT HEAD FROM BEHIND. THE #2147 EXTERNAL STAR WASHER MUST BE BETWEEN THE CHASSIS AND THE BONDING BLOCK IN ORDER TO GROUND THE CHASSIS

#2095 15 AMP DC BREAKER (OPTION CD15)

CD60DC & CD110DC ALSO AVAILABLE THE CUSTOMER IS RESPONSIBLE FOR WIRING TO THESE OPTIONS

1/2" & 3/4" KNOCKOUTS (5 ON TOP SURFACE)

CAN MOUNT 2 CHARGE CONTROLLERS MODELS C40 OR C30A

THE 15 AMP DC LOAD BREAKER MOUNTS HERE WITH 2 #496 6-32 X 3/8" PAN HEAD PHILIPS

4X #491-1 (10-32 X 3/8 FLAT HEAD)

1/2" & 3/4" KNOCKOUTS

2" & 2.5" KNOCKOUTS

2X #496 (6-32 X 3/8" SCREW)

#2507 GND STICKER

#2520 10-32 FH SCREW (CHASSIS)

#2544 #10 EXTERNAL SW

#442 10-32 NUT (TIGHT)

#2544 #10 EXTERNAL SW

#442 10-32 NUT S/S

LAST NUT IS HAND TIGHT FOR END USER TO INSTALL

1.25" & 1.5" KNOCKOUTS

2" & 2.5" KNOCKOUTS

#2063-1 (TRACE PART #)

A TOTAL OF 4 "CD" TYPE KNOCKOUTS ARE PROVIDED. LOWER ONES CAN BE USED FOR SOLAR ARRAY DISCONNECT TRACE MODEL CD60DC

REMOVE SLEEVING WHEN INSTALLING TO A DC LOAD BREAKER

...USE A 3/4" OFFSET 2" NIPPLE TO CONNECT TO A SW OR DR SERIES CONDUIT BOX

#2079 250 AMP HEINEMANN #GJ1-H3-U-0250-125VDC-1C-DC-25000AIC SECOND BREAKER IS OPTION GJ250

#2116 175 AMP HEINEMANN #GJ1-H3-U-0175-125VDC-1C-DC-25000AIC SECOND BREAKER IS OPTION GJ175

<p>TOLERANCES ARE: LINEAR XX = ±.02 XXX = ±.010 ANGULAR ± 2°</p> <p>BREAK ALL SHARP EDGES ALL ANGLES/BENDS 90° ALL DIMS PER ANSI Y14.5 ALL MACHINED SURFACES</p> <p>THIS TECHNICAL DATA IS CONSIDERED PROPRIETARY AND SHALL NOT BE DISCLOSED WITHOUT THE PERMISSION OF TRACE ENGINEERING.</p>	<p>DRAWN J.RINTOUL</p>	<p>DATE 5-30-95</p>	<p>Trace ENGINEERING</p>	<p>5916 195TH ST NE ARLINGTON, WA. 98223 360 435-8826/FAX 360 435-2229</p>		
	<p>MECH ROBIN GUDGEL</p>	<p>DATE 5-30-95</p>		<p>TITLE</p>		
	<p>ELEC C. FREITAS</p>	<p>DATE 5-30-95</p>	<p>DC DISCONNECT / OVERCURRENT MODULE</p>			
	<p>MFG C. SEIDER</p>	<p>DATE 5-31-95</p>	<p>SIZE A</p>	<p>DRAWING NO. DC250</p>		
	<p>PURCH K. NORDQUIST</p>	<p>DATE 5-31-95</p>	<p>SCALE NONE</p>	<p>REV B</p>	<p>SHEET 1 OF 1</p>	

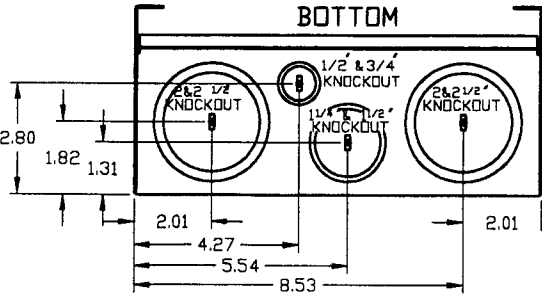
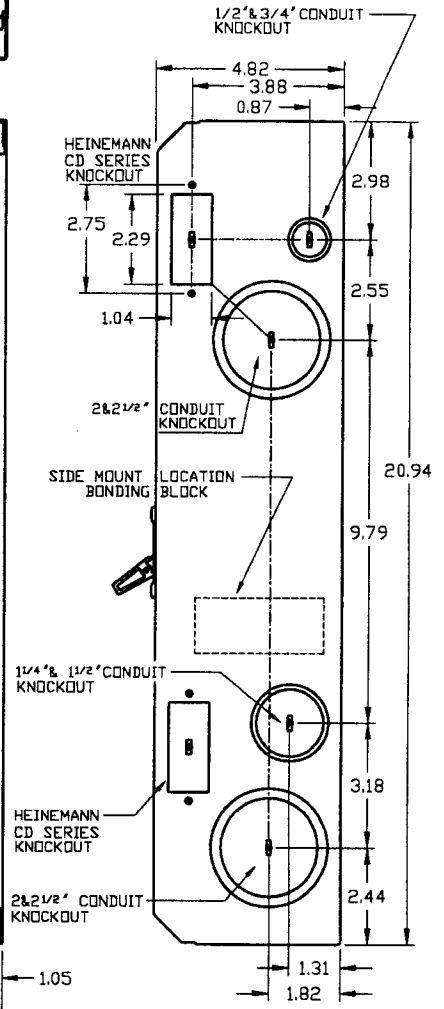
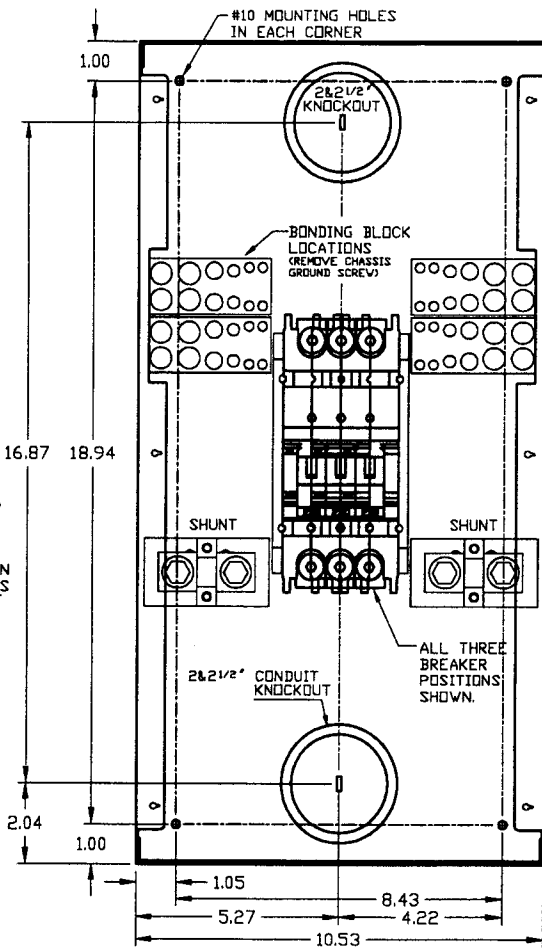
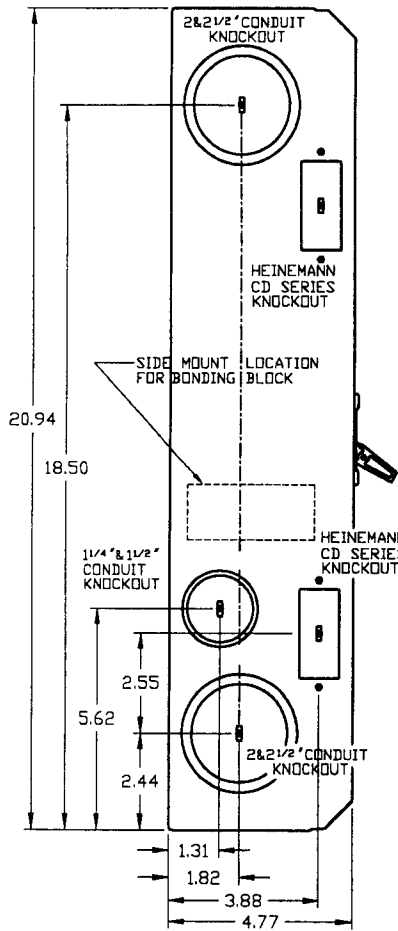
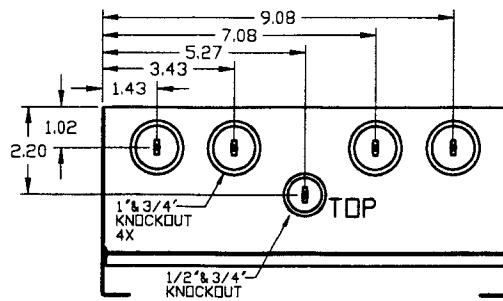

1. ALL INTERNAL PARTS MOUNTED WITH #10-32 OR #10-24 X 100" COUNTERSUNK SCREWS
2. THE FOUR DIFFERENT BONDING BLOCK MOUNTING POSITIONS ARE INTENDED FOR TRACE PN 2103-2 THE BONDING BLOCK IS AN OPTIONAL PART ONLY ONE BLOCK IS REQUIRED UNLESS USING DUAL 2/0 THIS BLOCK WILL ACCEPT:

QUANTITY	DIAMETER	MAX AWG	CIRCUIT
4	.609	(4/0)	BATTERY
2	.437	(3/0)	EARTH ROD
2	.312	(1AWG)	HIGH CURRENT EQUIPMENT GND
4	.250	(6AWG)	LOW CURRENT EQUIPMENT GND

3. THE LOCATIONS MARKED SHUNT WILL FIT DELTEC MODEL MKB 500-50 SHUNTS OR EQUIV.
4. THE DC LOAD BREAKER KNOCKOUT IS DESIGNED FOR HEINEMANN CD1 SERIES OR CARLINGSWITCH EA1 SERIES 15,60&110 AMP DC BREAKERS ARE STOCKED BY TRACE THE DC LOAD BREAKER IS AN OPTIONAL PART
5. 3/4" OFFSET 2" DIA NIPPLES ARE REQUIRED TO CONNECT TO TRACE SW AND DR SERIES CONDUIT BOXES



MOUNTING HOLES FOR #10 SCREWS IN ALL FOUR CORNERS

1/2 & 3/4" 1/2" KNOCKOUT 1/2 & 3/4" KNOCKOUT 1/2 & 3/4" KNOCKOUT 1/2 & 3/4" KNOCKOUT 1/2 & 3/4" KNOCKOUT

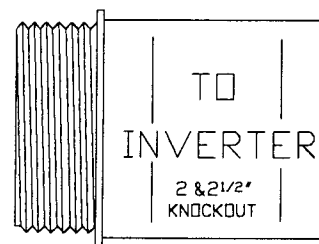

3/4" OFFSET NIPPLE REQUIRED FOR SW AND DR INSTALLATION TO THEIR RESPECTIVE CONDUIT BOXES

MAIN INVERTER BREAKER IS HEINEMANN GJ1 SERIES

175 AMP: TRACE MODEL GJ175
250 AMP: TRACE MODEL GJ250

HEINEMANN PART NO
175 AMP# GJ1-H3-U-0175-01C
250 AMP# GJ1-H3-U-0250-01C

MOUNT TO CHASSIS WITH 10-32 FLAT HEAD SCREW, STAR WASHER AND NUT
STAR WASHER TO BE INSTALLED BETWEEN CHASSIS AND TERMINALS TO PROVIDE BONDING TO CHASSIS
THIS MAY BE REMOVED WHEN USING THE BONDING BLOCK

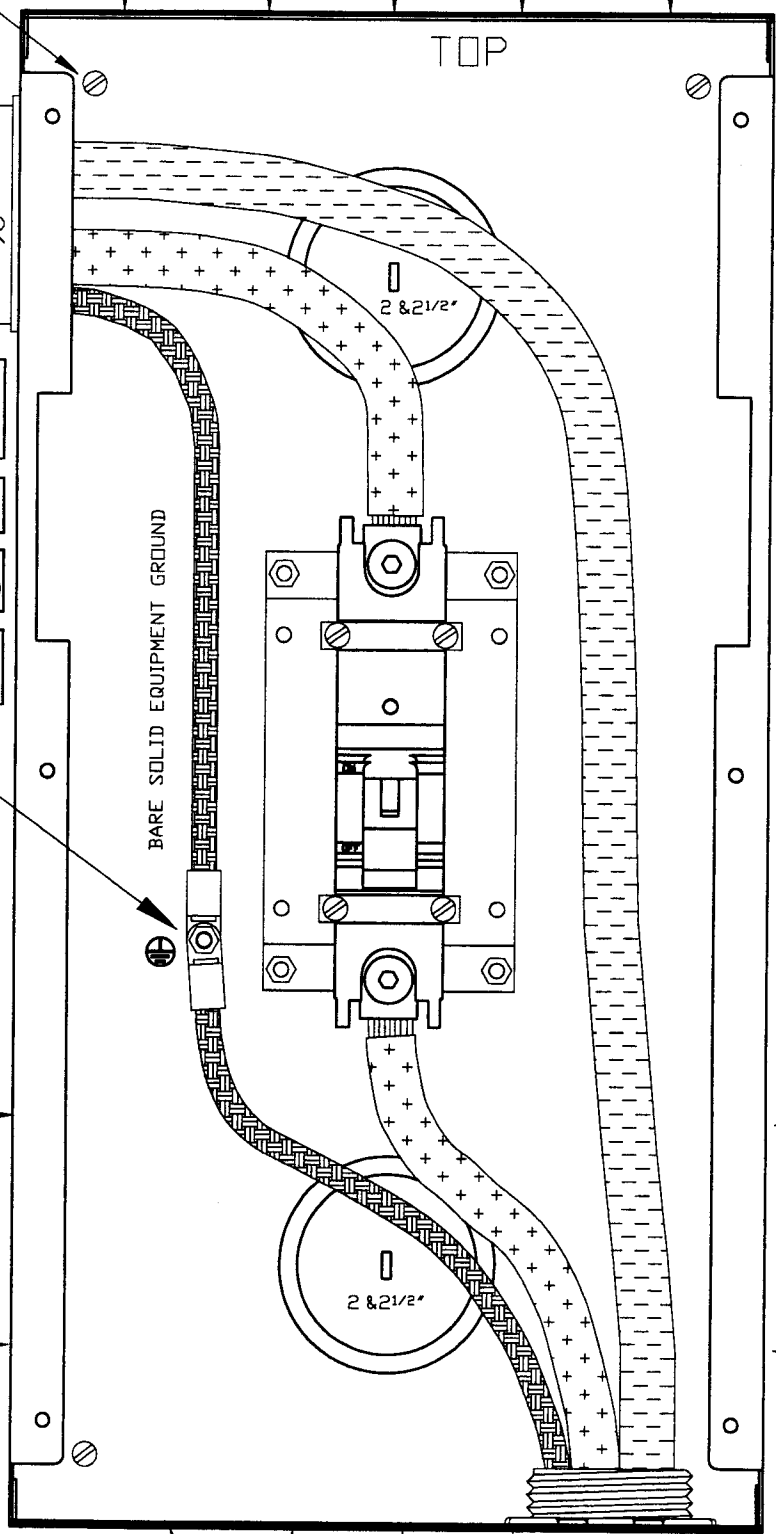

1/2 & 3/4" KNOCKOUT
15 AMP DC LOAD BREAKER KNOCKOUT
2 & 2 1/2" KNOCKOUT

1 1/4 & 1 1/2" KNOCKOUT

2 & 2 1/2" KNOCKOUT

1 1/4 & 1 1/2" KNOCKOUT
2 & 2 1/2" KNOCKOUT

FOR 175 AMP BREAKER, USE 2/0 AWG CABLE. FOR 250 AMP BREAKER, USE 4/0 AWG CABLE. ASSUME 75°C OR HIGHER CABLE RATING AND CABLE AMPACITY IS ROUNDED UP TO NEXT STANDARD BREAKER SIZE. NEC 240-3B. KEEP CONDUITS UNDER 24' LONG IF CARRYING MORE THAN 3 CONDUCTORS.

2 & 2 1/2" KNOCKOUT 1 1/4 & 1 1/2" KNOCKOUT
1/2 & 3/4" KNOCKOUT

TO BATTERIES

2 & 2 1/2" KNOCKOUT



TRACE MODEL DC175 OR DC250
THE MOST BASIC UNIT INSTALLATION. AVAILABLE IN EITHER 175 OR 250 AMP CONFIGURATION. FOR STACKED INSTALLATIONS ADD 'DUAL' TO THE MODEL NUMBER FOR TWO BREAKERS

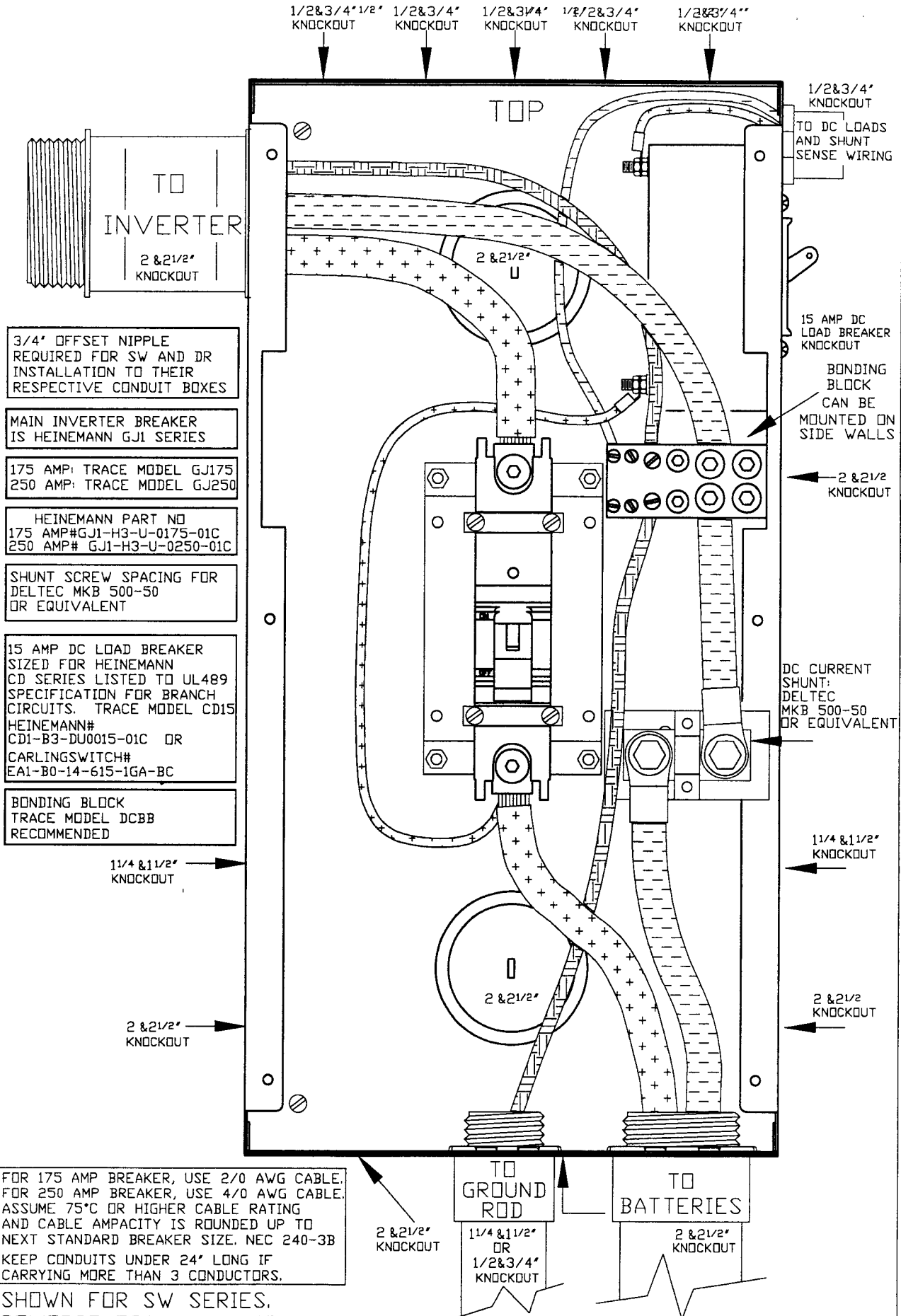

3/4" OFFSET NIPPLE
REQUIRED FOR SW AND DR
INSTALLATION TO THEIR
RESPECTIVE CONDUIT BOXES

MAIN INVERTER BREAKER
IS HEINEMANN GJ1 SERIES

175 AMP: TRACE MODEL GJ175
250 AMP: TRACE MODEL GJ250

HEINEMANN PART NO
175 AMP#GJ1-H3-U-0175-01C
250 AMP# GJ1-H3-U-0250-01C

SHUNT SCREW SPACING FOR
DELTEC MKB 500-50
OR EQUIVALENT

15 AMP DC LOAD BREAKER
SIZED FOR HEINEMANN
CD SERIES LISTED TO UL489
SPECIFICATION FOR BRANCH
CIRCUITS. TRACE MODEL CD15
HEINEMANN#
CD1-B3-DU0015-01C OR
CARLINGSWITCH#
EA1-B0-14-615-1GA-BC

BONDING BLOCK
TRACE MODEL DCBB
RECOMMENDED

FOR 175 AMP BREAKER, USE 2/0 AWG CABLE.
FOR 250 AMP BREAKER, USE 4/0 AWG CABLE.
ASSUME 75°C OR HIGHER CABLE RATING
AND CABLE AMPACITY IS ROUNDED UP TO
NEXT STANDARD BREAKER SIZE. NEC 240-3B
KEEP CONDUITS UNDER 24' LONG IF
CARRYING MORE THAN 3 CONDUCTORS.

SHOWN FOR SW SERIES.
REVERSE FOR DR SERIES.



TRACE MODEL **DC175 OR DC250**
SINGLE INVERTER INSTALLATION WITH 15 AMP DC BRANCH CIRCUIT
FOR DC REFRIGERATOR AND EQUIPMENT ROOM DC LIGHTS. BONDING
BLOCK WHERE ALL SYSTEM GROUNDS AND NEGATIVES TIE TOGETHER.
SHOWN WITH USER SUPPLIED SHUNT FOR METERING

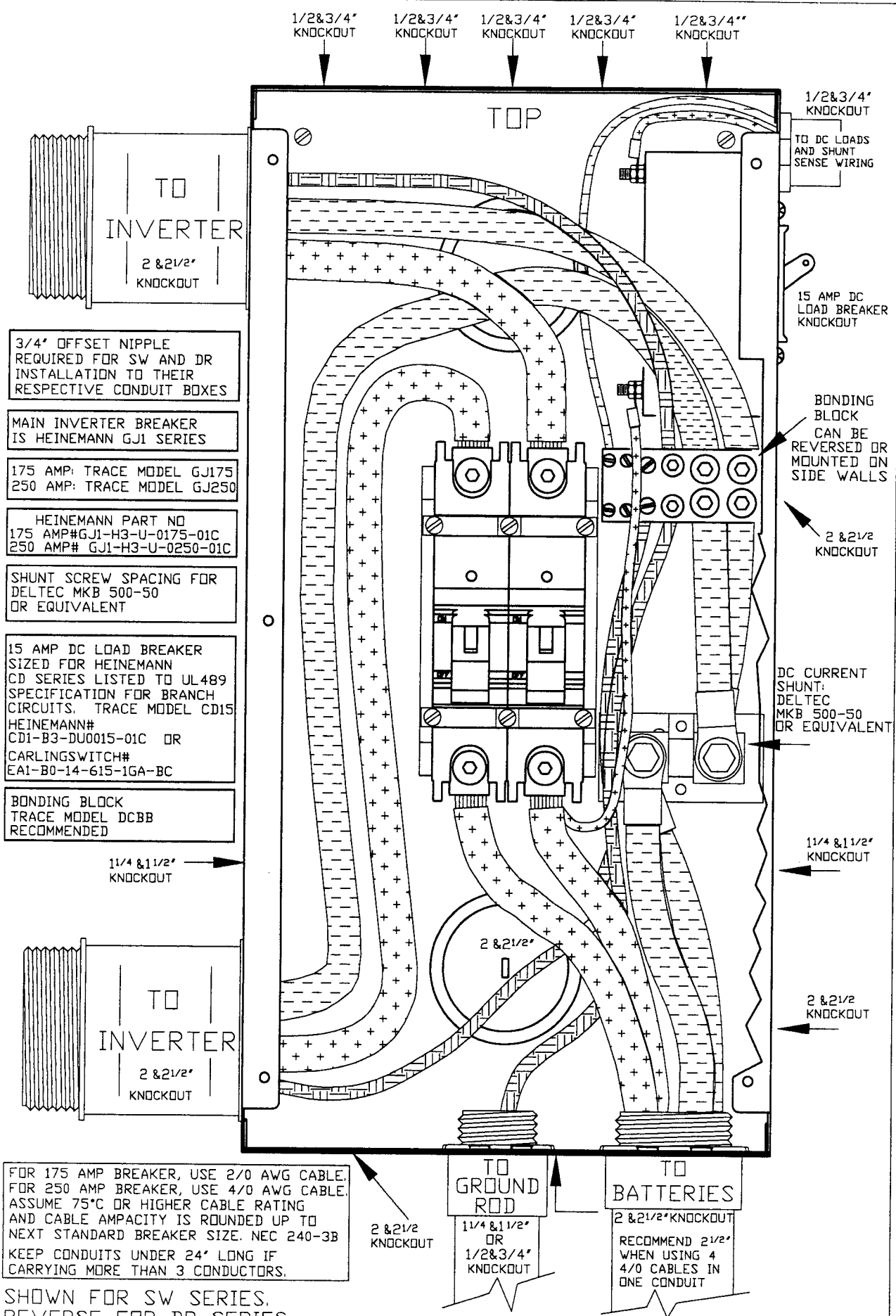

3/4" OFFSET NIPPLE
REQUIRED FOR SW AND DR
INSTALLATION TO THEIR
RESPECTIVE CONDUIT BOXES

MAIN INVERTER BREAKER
IS HEINEMANN GJ1 SERIES

175 AMP: TRACE MODEL GJ175
250 AMP: TRACE MODEL GJ250

HEINEMANN PART NO
175 AMP#GJ1-H3-U-0175-01C
250 AMP# GJ1-H3-U-0250-01C

SHUNT SCREW SPACING FOR
DELTEC MKB 500-50
OR EQUIVALENT

15 AMP DC LOAD BREAKER
SIZED FOR HEINEMANN
CD SERIES LISTED TO UL489
SPECIFICATION FOR BRANCH
CIRCUITS. TRACE MODEL CD15
HEINEMANN#
CD1-B3-DU0015-01C OR
CARLINGSWITCH#
EA1-B0-14-615-1GA-BC

BONDING BLOCK
TRACE MODEL DCBB
RECOMMENDED

FOR 175 AMP BREAKER, USE 2/0 AWG CABLE.
FOR 250 AMP BREAKER, USE 4/0 AWG CABLE.
ASSUME 75°C OR HIGHER CABLE RATING
AND CABLE AMPACITY IS ROUNDED UP TO
NEXT STANDARD BREAKER SIZE. NEC 240-3B
KEEP CONDUITS UNDER 24' LONG IF
CARRYING MORE THAN 3 CONDUCTORS.

SHOWN FOR SW SERIES.
REVERSE FOR DR SERIES.



TRACE MODEL **DC175** OR **DC250** (WITH SECOND BREAKER)
DUAL INVERTER INSTALLATION WITH 15 AMP DC BRANCH CIRCUIT
FOR DC REFRIGERATOR AND EQUIPMENT ROOM DC LIGHTS. BONDING
BLOCK WHERE SYSTEM GROUNDS AND NEGATIVES TIE TOGETHER.
SHOWN WITH USER SUPPLIED SHUNT FOR METERING



5916 - 195th Street N.E., Arlington, WA 98223 Phone: (360) 435-8826 Fax: (360) 435-2229

visit our website at: www.traceengineering.com